

2000±50

歐規合格線材供應商
Available European safety approve cable supplier

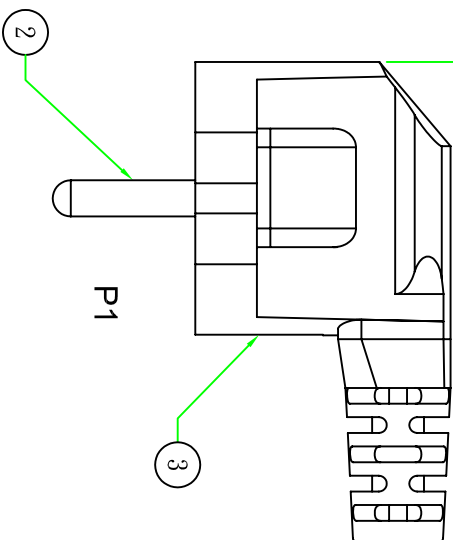

H05VV-F 3G 0.75mm²

1

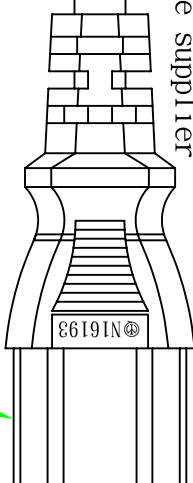

P2

黃綠色 (Y/G)

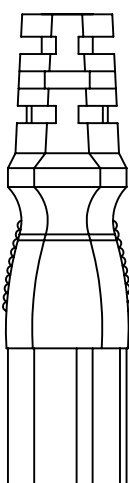

藍色 (BLUE)
棕色 (BROWN)

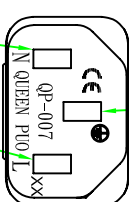

接線表/Connection Label	
P1	芯線顏色/Core color
L	棕色芯線/Brown core
N	藍色芯線/Blue core
E	黃綠芯線/Yellow&Green core

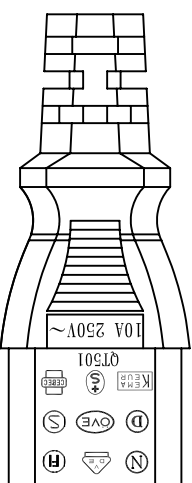
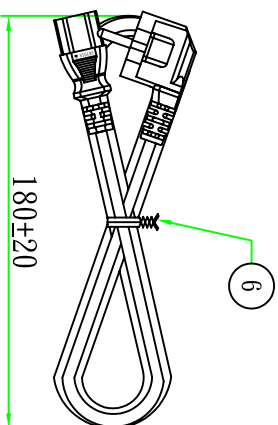
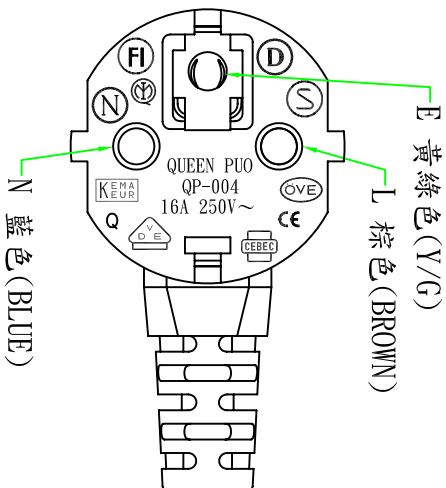

Customer confirmation

date:

Bill of Material

No.	品名	規格/描述	PCS	PCS
①	扎帶/Tie	白色(WHITE)PE有鐵芯紮帶,符合RoHS.	1PCS	1PCS
②	內膜/Inner	尾叉內膜 WHITE	1PCS	1PCS
③	端子/Terminal	2*4 尾叉端子	3PCS	3PCS
④	膠料/Plastic	45P-白色(WHITE)低鉛低銅PVC料	g	
⑤	端子/Terminal	法支架 白色(WHITE)	1PCS	1PCS
⑥	電源線/Cable	H05VV-F 3G 0.75mm ² 2M WHITE	1PCS	1PCS



版本

設置內容

標普

設置日期

昆璞電線組(深圳)有限公司

Part Name: QP004+QP007

(1407201004)

QUEEN PUO ELECTRIC CO. LTD

H05VV-F 3G 0.75mm² 2M WHITE

核準

審核

繪制

單位

mm

2014.03.25

客戶編號

00125

客戶品號

NCDEAWW-2

昆璞品號

10100125004042

比例

1:1

