

500±30

Available European safety approve cable supplier

P1

H05VV-F 3G 0.75mm²

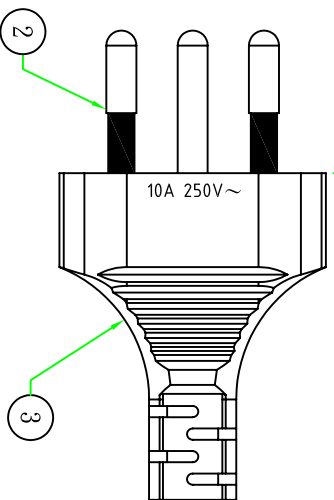

1

3

2

P2

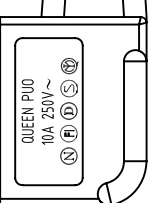

E 黃綠色 (Y/G)

L 棕色 (BROWN)

N 藍色 (BLUE)

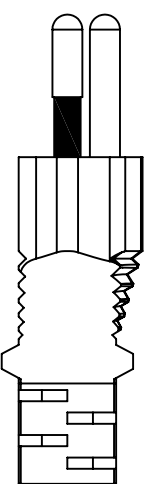
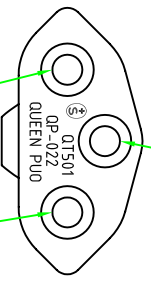

接線表/Connection label		
P1	芯線顏色/Core color	P2
L	棕色芯線/Brown core	L
N	藍色芯線/Blue core	N
E	黃綠芯線/Yellow&Green core	E

E 黃綠色 (Y/G)

N 藍色 (BLUE)
L 棕色 (BROWN)

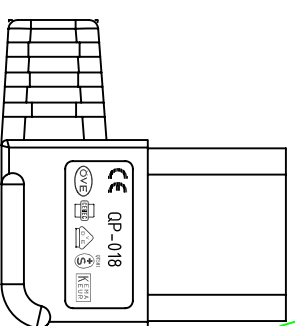
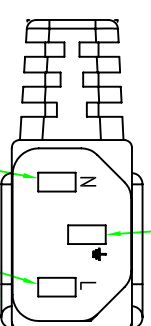

5 6 7

BUNDLE

Customer confirmation

date:

Bill of Material		
No.	品名	規格/描述
③	內膠/Inner	尾叉內膠 WHITE
①	端子/Terminal	2*4尾叉端子 3PCS
③	膠料/Plastic	45P-GREY(GY307) 低鉛低銅PVC料 g
②	端子/Terminal	瑞士三叉支架 BLACK IPCS
①	電源線/Cable	H05VV-F 3G 0.75mm ² GREY(GY307) L=0.5M IPCS

△

變更插頭為半絕緣尾插變更刻字客品

Cyrus

2013.02.18

版本

昆璞電線組(深圳)有限公司

據普

設置日期
(1000759022)

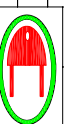

QUEEN PIO ELECTRIC CO. LTD

Part Name: QP0224QP018
H05VV-F 3G 0.75mm² GREY(GY307) L=0.5M

核準

審核

繪制

客戶編號

00125

單位

mm

2010.05.22

Hank

客戶品號

10100125022158

比例

1:1

