

3000±50

Available European safety approve cable supplier

H05VV-F 3G 1.0mm²

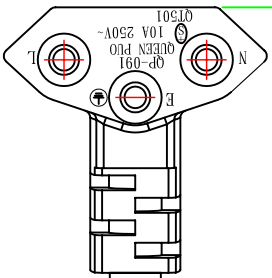

1

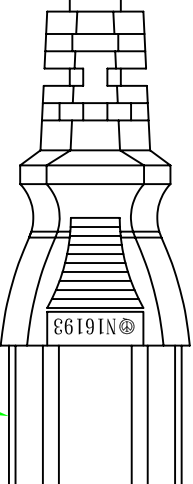

5 4 3

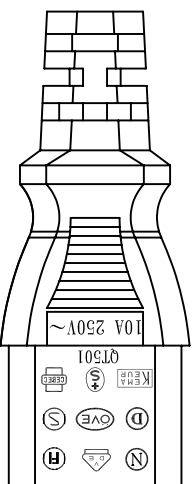
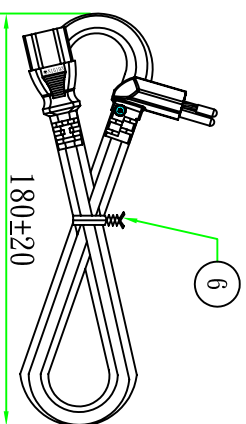
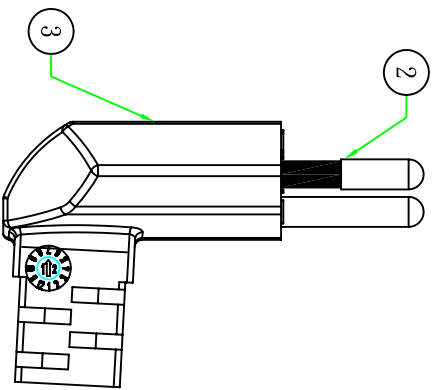
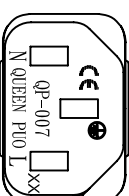
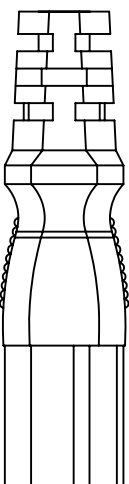

Customer confirmation

date:

Bill of Material

No.	品名	规格/描述	用量
①	扎带/Tie	白色(WHITE)PE有磁芯扎带,符合RoHS.	IPCS
②	内膜/Inner	尾叉内膜 WHITE	IPCS
③	端子/Terminal	2*4 尾叉端子	3PCS
④	胶料/Plastic	45P-WHITE低铅低烟PVC料	g
⑤	端子/Terminal	瑞士三叉支架 WHITE	IPCS
⑥	电源线/Cable	H05VV-F 3G 1.0mm ² 3M WT	IPCS



版本

设置内容

警告

昆璞電線組(深圳)有限公司
Part Name: (QP091(絕緣P1V))QP007 (1710295091)

QUEEN P10 ELECTRIC CO. LTD
H05VV-F 3G 1.0mm² 3M WT

審核
Hank
2017/09/20

繪制
Adolf
2017.09.18

客戶編號
00125
單位
mm

客戶品號
SPCW1T12A10-3
視角
1:1

昆璞品號
10100125091008
比例
1:1