

1000±50

Available European safety approve cable supplier

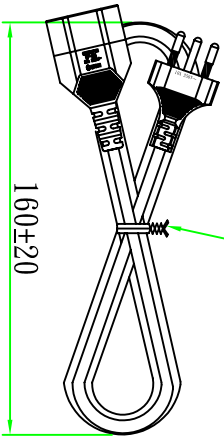
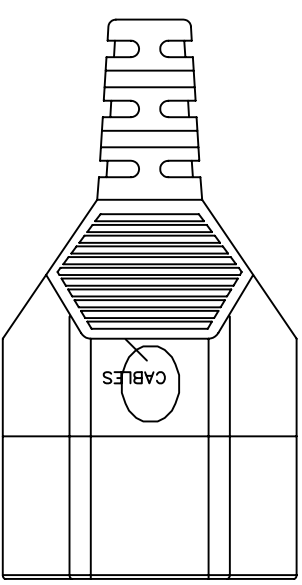
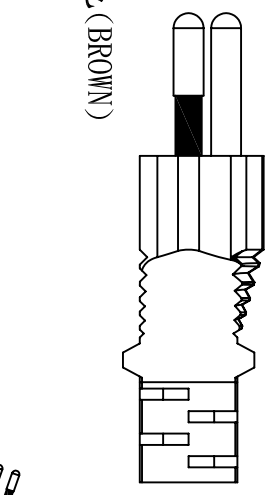
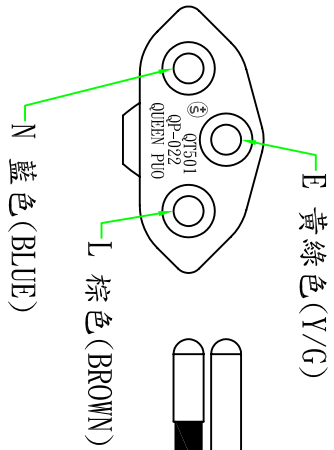
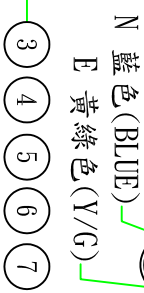
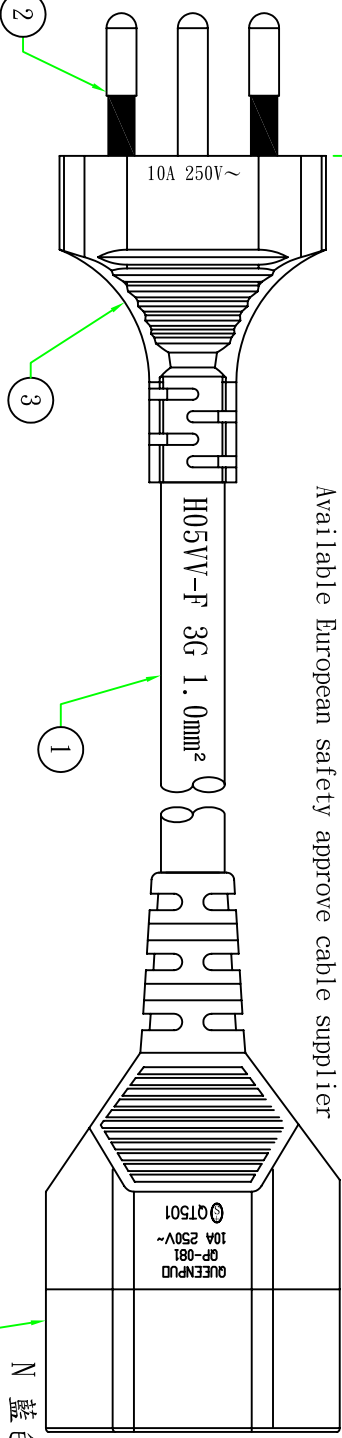

接線表/Connection Label	
P1	芯線顏色/Core color
L	棕色芯線/Brown core
N	藍色芯線/Blue core
E	黃綠芯線/Yellow&Green core

Customer confirmation

date:

Bill of Material

No.	品名	規格/描述	用量
①	扎帶/Tie	黑色(BLACK)PE有織芯紮帶,符合Rolls.	1PCS
②	內膜/Inner	瑞士母座旋轉PIN BLACK	1PCS
③	內膜/Inner	瑞士母座保護蓋 BLACK	1PCS
④	內膜/Inner	瑞士母座外殼 BLACK	1PCS
⑤	端子/Terminal	T-138銅管(QP081用) PS-0	3PCS
⑥	膠料/Plastic	45P-BLACK低鉛低鎘PVC料	g
⑦	端子/Terminal	瑞士三叉支架 BLACK	1PCS
⑧	電源線/Cable	H05VV-F 3G 1.0mm² 1M BK	1PCS

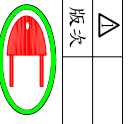

昆璜電線組(深圳)有限公司
QUEEN PUO ELECTRIC CO. LTD

Part Name: QP022(絕緣PIN)+QP081(130065T022)

客戶編號: H05VV-F 3G 1.0mm² 1M BK
客戶品號: SPNV110B-1
昆璜品號: 10100125022145

版本	核對	繪制	審核	日期	單位	比例
		Adolf		2013.11.25	mm	1:1

設變內容: 昆璜電線組(深圳)有限公司
設變日期: 130065T022