

2000±50

歐規合格線材供應商

Available European safety approve cable supplier

H05VV-F 3G 0.75mm²

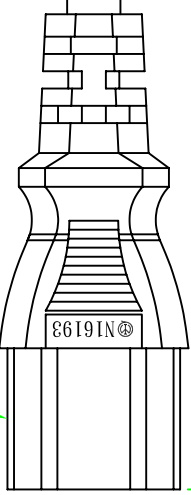
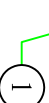
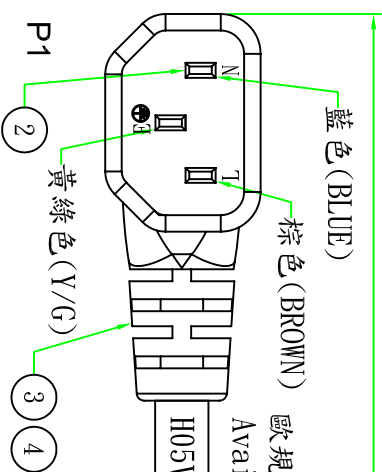

黃綠色 (Y/G)

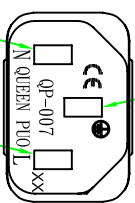

接線表/Connection Label	
P1	芯線顏色/Core color
L	棕色芯線/Brown core
N	藍色芯線/Blue core
E	黃綠芯線/Yellow&Green core

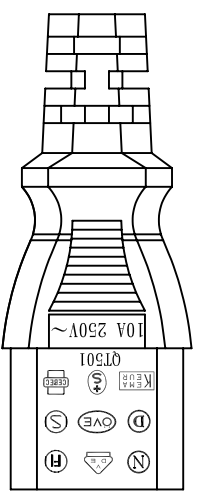
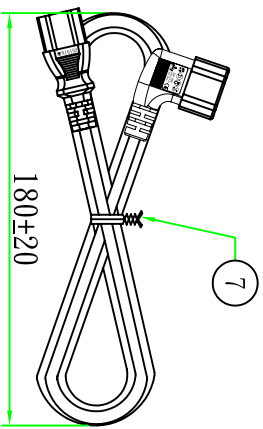
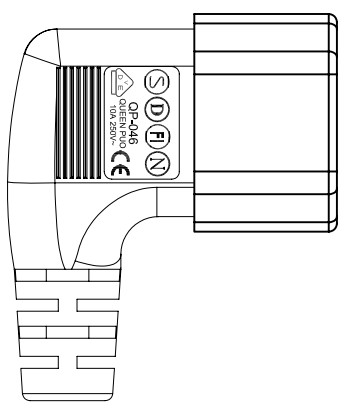

棕色 (BROWN)

藍色 (BLUE)

Customer confirmation

date:

Bill of Material

No.	品名	規格/描述	用量
⑦	扎帶/Tie	黑色(BLACK)PE有纖芯聚帶,符合RoHS.	1PCS
⑥	內膜/Inner	尾叉內膜 WHITE	1PCS
⑤	端子/Terminal	2*4 尾叉端子	3PCS
④	膠料/Plastic	45P-BLACK低鉛低編PVC料	g
③	內膜/Inner	公叉外殼 BLACK	1PCS
②	端子/Terminal	2*4公叉端子	3PCS
①	電源線/Cable	H05VV-F 3G 0.75mm ² 2M BK	1PCS



版本	設置內容	繪制	審核	校準
△	昆璞電線組(深圳)有限公司	Adolf	2014.09.25	

Part Name:	客戶編號	客戶品號	單位	視角	比例
H05VV-F 3G 0.75mm ² 2M BK	00125	SPVBC14A-2	mm	1:1	

設置日期 (1407850046)